

# COMMON THREAD PROFILES

**ISO (M) and UN**

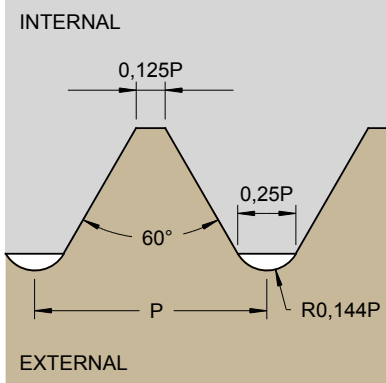

**Whitworth (W)**

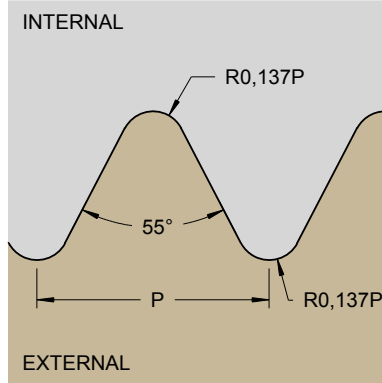

**BSPT**

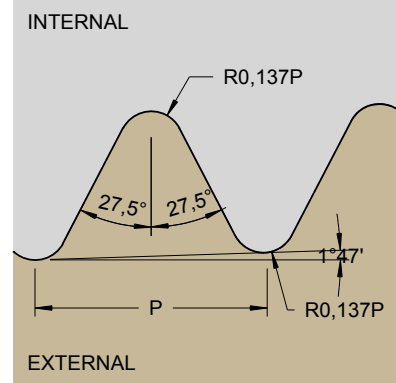

**MJ and UNJ**

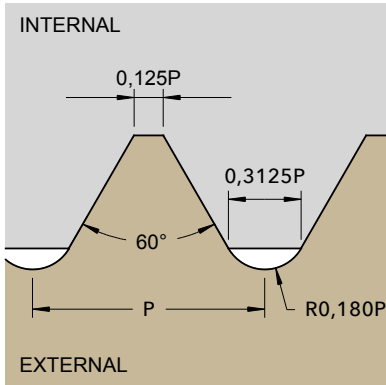

**NPT and NPTF**

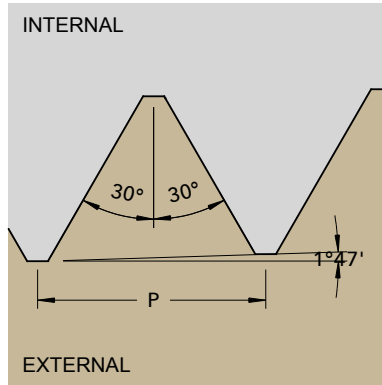

**NPSF**

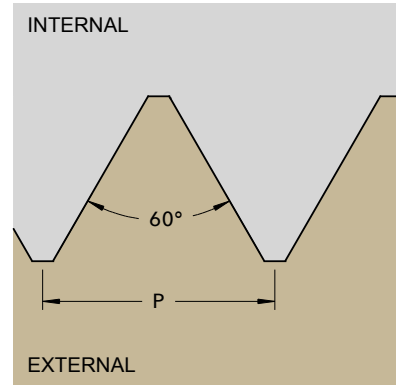

**Trapez DIN 103**

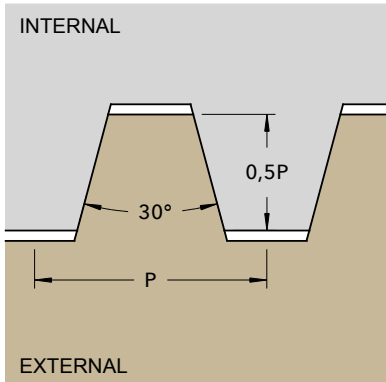

**ACME**

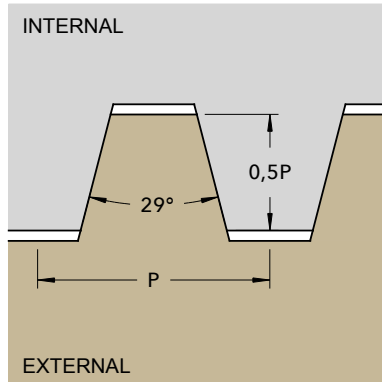

**STUB ACME**

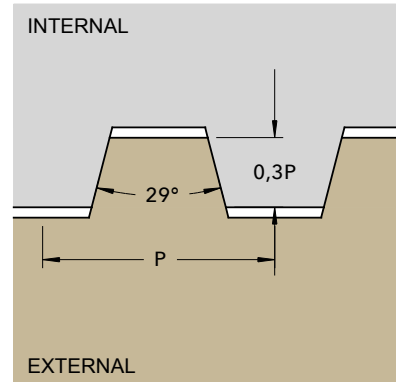

**Round DIN 405**

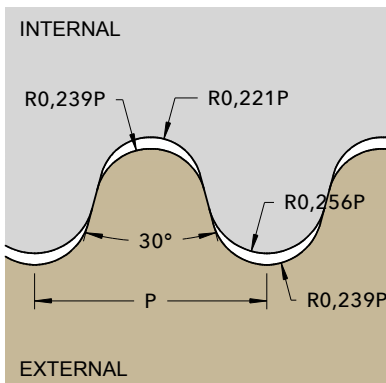

**PG DIN 40430**

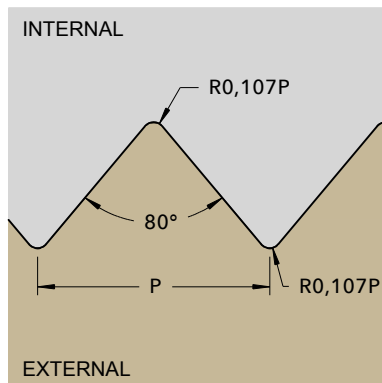

**SG DIN 513**

